

Side

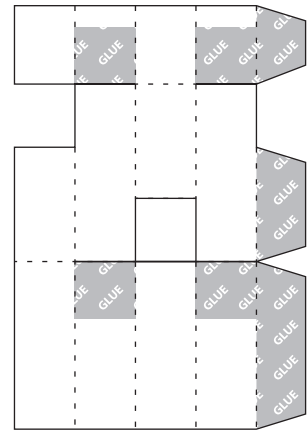

Crank Pieces

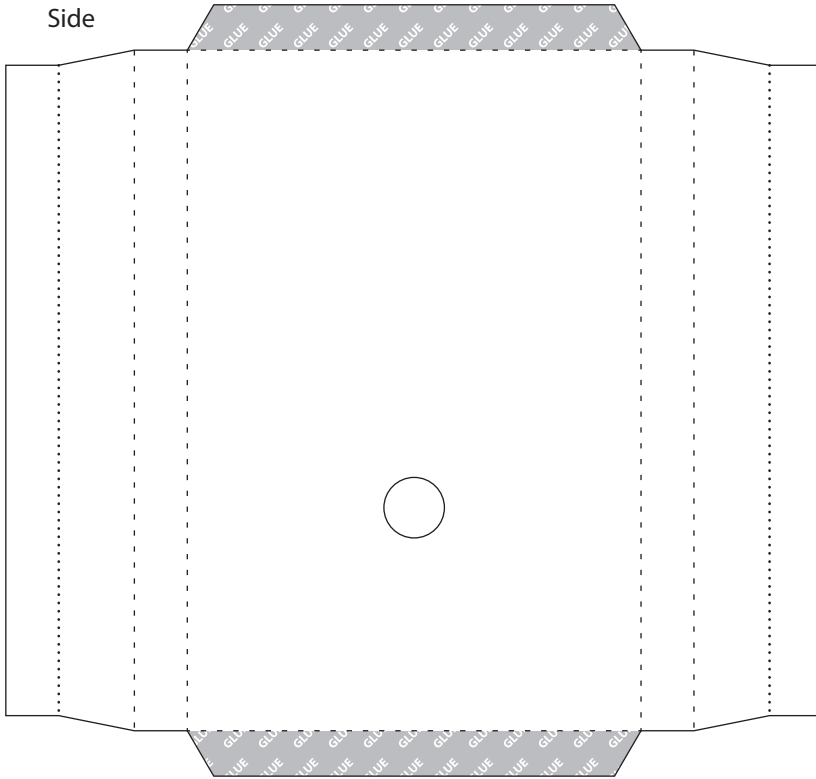
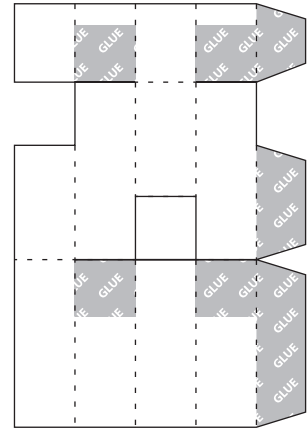

Side

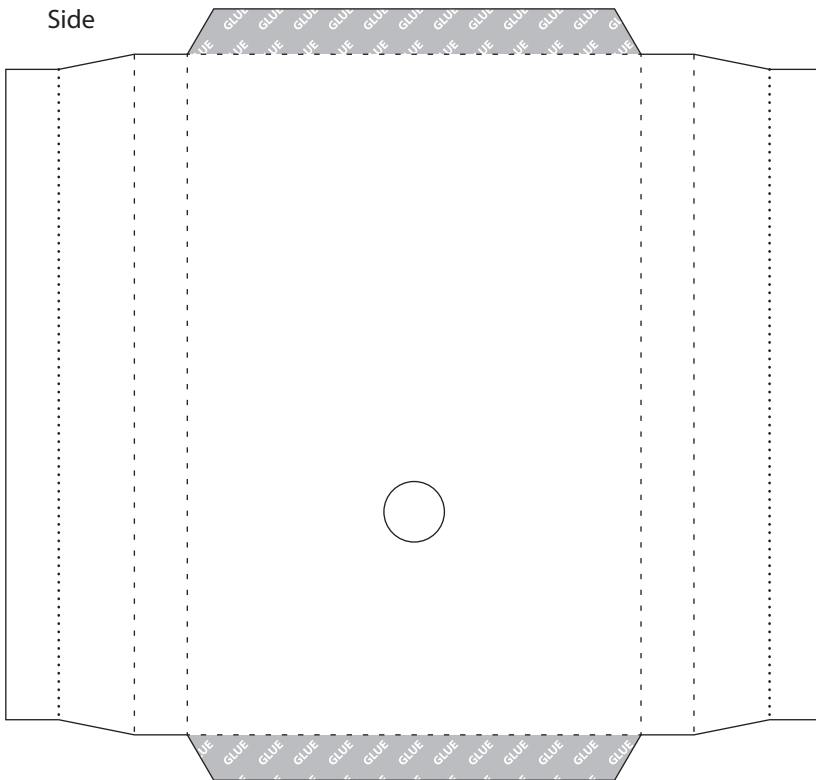

Handle

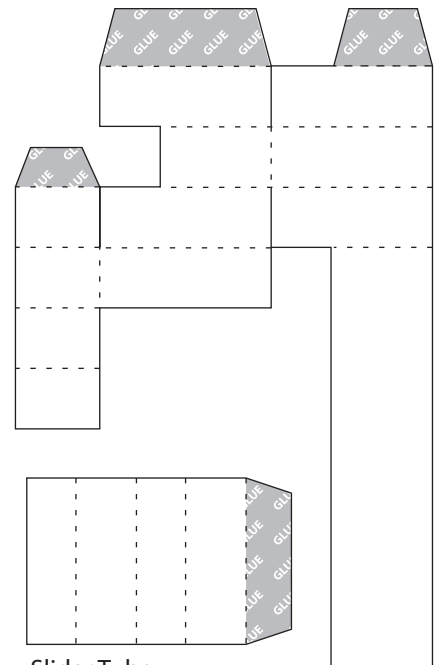

Slider Tube

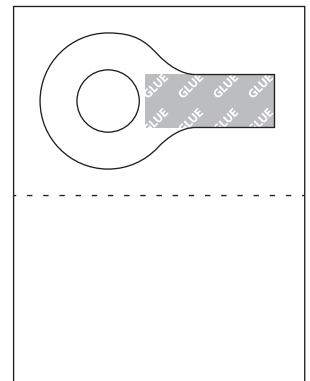
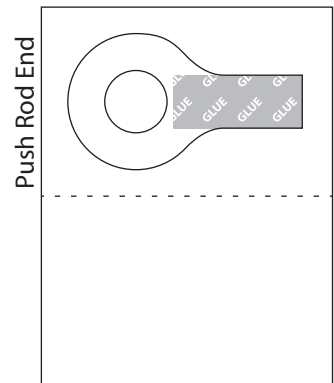
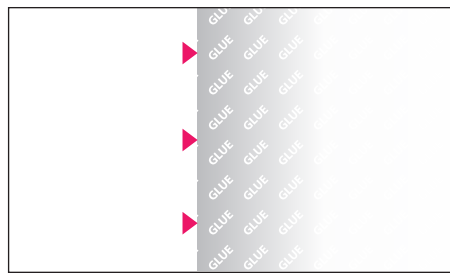
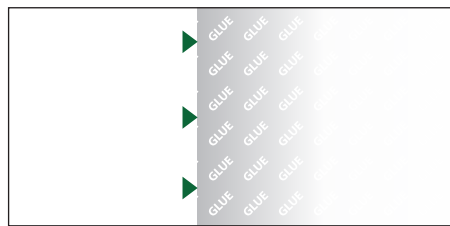
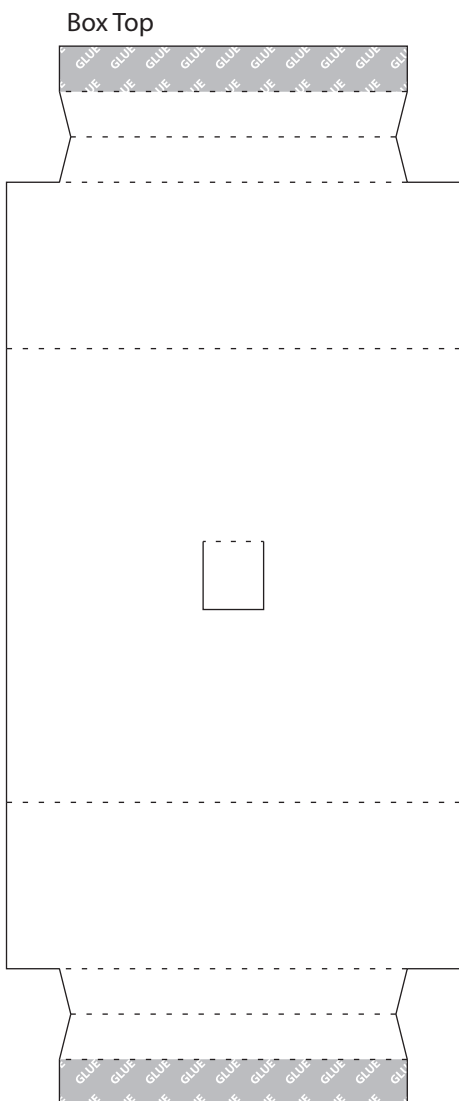
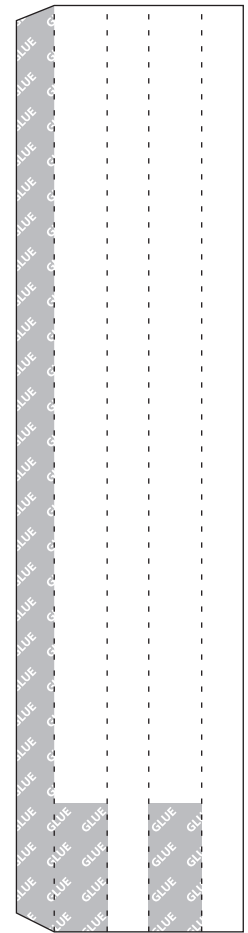
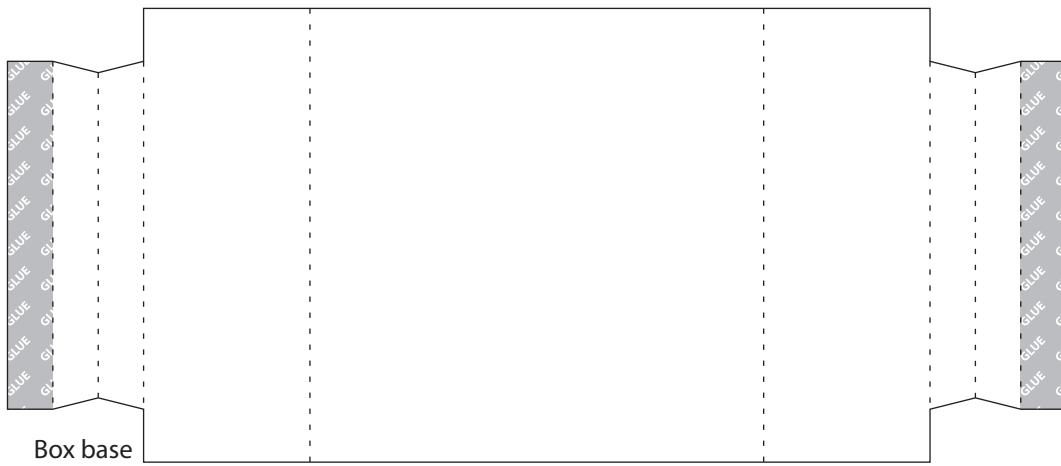

Crank Slider Mechanism.

Use this mechanism to learn how crank sliders work or as the starting point for your own mechanisms.

Construction instructions are at www.robives.com/blog/cs3